

# *Gen-Eye Prism<sup>®</sup> 2.0*

## *Video Pipe Inspection/Location Systems*

### *Operating Instructions*



Your Gen-Eye Prism 2.0 Video Pipe Inspection/Location System is designed to give you years of trouble-free, profitable service. However, no machine is better than its operator.

Read, understand and follow all safety warnings and instructions provided with the product. Failure to follow the warnings and instructions may result in electric shock and/or serious injury. Save all warnings and instructions for future reference.

**SAVE THESE INSTRUCTIONS!**

***General***  
***PIPE CLEANERS***



**! WARNING**

Read and understand operator's manual before using this machine. Failure to follow operating instructions could result in death or serious injury.

**WARNING!** Read and understand all instructions. Failure to follow all instructions listed below may result in electric shock, fire and/or serious personal injury. Replacement manuals are available upon request at no charge, or may be downloaded from our website, [www.drainbrain.com](http://www.drainbrain.com). Instructional videos are available for download on our website, and may be ordered. If you have any questions or problems, please call General's customer service department at 412-771-6300.

**SAVE THESE INSTRUCTIONS!**

These instructions are intended to familiarize all personnel with the safe operation and maintenance procedures for the Gen-Eye Prism 2.0 Video Pipe Inspection/Location Systems.

**SAFETY SYMBOLS**



This is the safety alert symbol. It is used to alert you to potential personal injury hazards. Obey all safety messages that follow this symbol to avoid possible injury or death.

**! DANGER**

DANGER indicates a hazard with a high level of risk which, if not avoided, will result in death or serious injury.

**! WARNING**

WARNING indicates a hazard with a medium level of risk which, if not avoided, could result in death or serious injury.

**! CAUTION**

CAUTION indicates a hazard with a low level of risk which, if not avoided, will result in minor or moderate injury.

**! WARNING**



Electric shock resulting in death can occur if you plug this machine into an improperly wired outlet. If the ground wire is electrified, you can be electrocuted by just touching the machine, even when the power switch is off. A ground fault circuit interrupter will not protect you in this situation. Use a UL approved tester to determine if the outlet is safe.

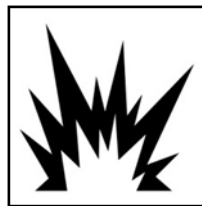

Do not operate power tools in explosive atmospheres, such as in the presence of flammable liquids, gases, or dust. Power tools create sparks which may ignite the dust or fumes.



Always wear safety glasses and rubber soled, non-slip shoes. Use of this safety equipment may prevent serious injury.

## GENERAL SAFETY RULES



### WARNING

Read and understand all instructions. Failure to follow all instructions listed below may result in electric shock, fire, and/or serious injury.

#### SAVE THESE INSTRUCTIONS!

### Work Area

1. **Keep work area clean and well lit.** Cluttered benches and dark areas invite accidents.
2. **Do not operate power tools in explosive atmospheres, such as in the presence of flammable liquids, gases, or dust.** Power tools create sparks which may ignite the dust or fumes.
3. **Keep bystanders, children, and visitors away while operating a power tool.** Distractions can cause you to lose control.

### Electrical Safety

1. **Grounded tools must be plugged into an outlet, properly installed and grounded in accordance with all codes and ordinances. Never remove the grounding prong or modify the plug in any way. Do not use any adapter plugs. Check with a qualified electrician if you are in doubt as to whether the outlet is properly grounded.** If the tool should electrically malfunction or break down, grounding provides a low resistance path to carry electricity away from the user.
2. **Avoid body contact with grounded surfaces such as pipes, radiators, ranges and refrigerators.** There is an increased risk of electric shock if your body is grounded.
3. **Do not expose power tools to rain or wet conditions.** Water entering a power tool will increase the risk of electric shock.
4. **Do not abuse the cord. Never use the cord to carry the tools or pull the plug from an outlet. Keep cord away from heat, oil, sharp edges or moving parts. Replace damaged cords immediately.** Damaged cords increase the risk of electric shock.
5. **When operating a power tool outside use an outdoor extension cord marked "W-A" or "W".** These cords are rated for outdoor use and reduce the risk of electric shock.
6. **Keep all electric connections dry and off the ground.** Reduces the risk of electric shock.
7. **Do not touch plugs or tools with wet hands.** Reduces the risk of electric shock.

### Personal Safety

1. **Stay alert, watch what you are doing and use common sense when operating a power tool. Do not use tool while tired or under the influence of drugs, alcohol, or medication.** A moment of inattention while operating power tools may result in serious personal injury.
2. **Dress properly. Do not wear loose clothing or jewelry. Contain long hair. Keep your hair, clothing, and gloves away from moving parts.** Loose clothes, jewelry, or long hair can be caught in moving parts.
3. **Remove adjusting keys or switches before turning the tool on.** A wrench or key that is left attached to a rotating part of the tool may result in personal injury.

4. **Do not overreach. Keep proper footing and balance at all times.** Proper footing and balance enables better control of the tool in unexpected situations.
5. **Always wear safety glasses and rubber soled, non-slip shoes.** Dust mask, non-skid safety shoes, hard hat, or hearing protection must be used for appropriate conditions.
6. **Rubber glove inserts should be worn for health and safety reasons.** Sewer lines are unsanitary and may contain harmful bacteria.
7. **Check to make sure pipes are not electrically hot.** In some cases, ground circuits may be returned to cast iron pipes causing them to be electrically charged. Care should be taken to check the entire length on any pipe you are going to inspect.
8. **Prevent object and liquid entry.** Never push objects of any kind into this product through the openings as they may touch dangerous voltage points or short circuit to parts that could result in a fire or electric shock. Never spill liquid of any kind on the product.

### Tool Use and Care

1. **Use clamps or other practical way to secure and support the workpiece to a stable platform.** Holding the work by hand or against your body is unstable and may lead to loss of control.
2. **Do not force tool. Use the correct tool for your application.** The correct tool will do the job better and safer at the rate for which it is designed.
3. **Do not use tool if switch does not turn it on or off.** Any tool that cannot be controlled with the switch is dangerous and must be repaired.
4. **Disconnect the plug from the power source before making any adjustments, changing accessories, or storing the tool.** Such preventative safety measures reduce the risk of starting the tool accidentally.
5. **Store idle tools out of reach of children and other untrained persons.** Tools are dangerous in the hands of untrained users.
6. **Maintain tools with care.** Keep cutting tools sharp and clean. Properly maintained tools, with sharp cutting edges are less likely to bind and are easier to control.
7. **Inspect for misalignment or binding of moving parts, breakage of parts, and any other condition that may affect the tool's operation.** If damaged, have the tool serviced before using. Many accidents are caused by poorly maintained tools.
8. **Only use accessories that are recommended by the manufacturer for your model.** Accessories that may be suitable for one tool may become hazardous when used on another tool.

### Service

1. **Tool service must be performed only by qualified repair personnel.** Service or maintenance performed by unqualified repair personnel could result in injury.
2. **When servicing a tool, use only identical replacement parts. Follow instructions in the Maintenance section of this manual.** Use of unauthorized parts or failure to follow Maintenance Instructions may create a risk of electric shock or injury.

## SPECIFIC SAFETY RULES

1. **Do not use tool if switch does not turn it ON or OFF.** Any tool that cannot be controlled with the switch is dangerous and must be repaired.

## Gen-Eye Prism<sup>®</sup> 2.0 Video Pipe Inspection/Location System

2. **Be sure that the unit is plugged into a properly grounded receptacle.** If in doubt, check receptacle before plugging in machine. Check the power cord to see that there are no cuts or frays, and that the grounding prong on the plug is still in place.
3. **If the power cord supplied with the machine is not long enough, be sure to use a 16 gauge heavy duty extension cord no more than 50 feet long and in good condition.** Using lighter cords can result in severe power loss and motor overheating.
4. **Be careful when cleaning drains where cleaning chemicals have been used.** Avoid direct contact with corrosive drain cleaners. Drain cleaning chemicals can cause serious burns, as well as damage the cable. Neutralize or remove corrosive drain cleaners in the drain before starting the job.
5. **Do not operate machine if operator or machine is standing in water.** Will increase risk of electrical shock.
6. **Wear safety glasses and rubber soled, non-slip shoes.** Use of this safety equipment may prevent serious injury.
7. **Protect against lightning.** For added protection for this product during a lightning storm, or when it is left unattended and unused for long periods of time, unplug it from the wall outlet. This will prevent damage to the product due to lightning and power surges.
8. **Protect against excessive heat.** The product should be situated away from heat sources such as radiators, heat registers, stoves, or other products (including amplifiers) that produce heat.

## FEATURES

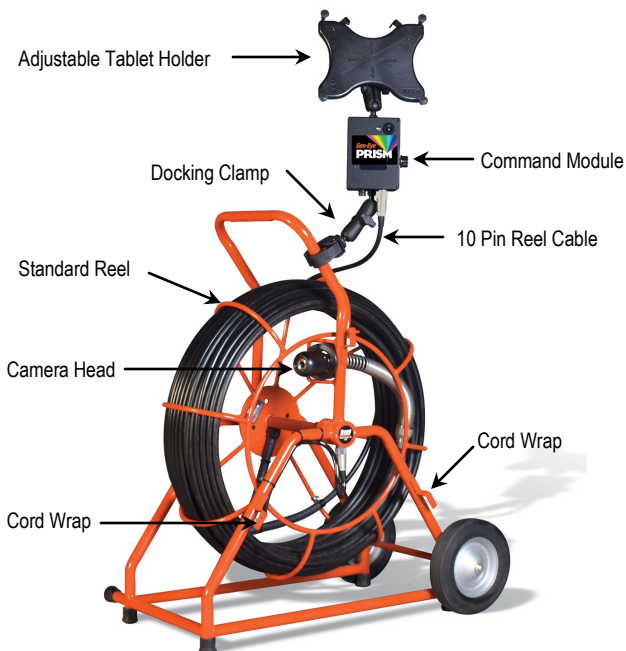

## ABOUT THE INSPECTION CAMERA

The Gen-Eye video pipe inspection and location system is manufactured for harsh environments, however, it should be handled with care. Use the Gen-Eye as an inspection tool only, never as a drain cleaning tool. Damage may occur if the camera head is dropped or "buted" severely against the pipe or any other hard surface. Once you see the obstruction, remove the camera head from the line and use the proper tool to clear the stoppage.

The stainless steel camera housing is made to protect the camera and internal electronics. However, it can be damaged by severe impacts which could cause failure of the O-ring seals or the electronics within. The camera, housing, and lens should be checked thoroughly after each use for signs of damage and, if required, should be corrected prior to further use.

## GEN-EYE PRISM COMMAND MODULE

The Command Module should not be used in wet locations or in the rain, as moisture may cause damage to the unit.

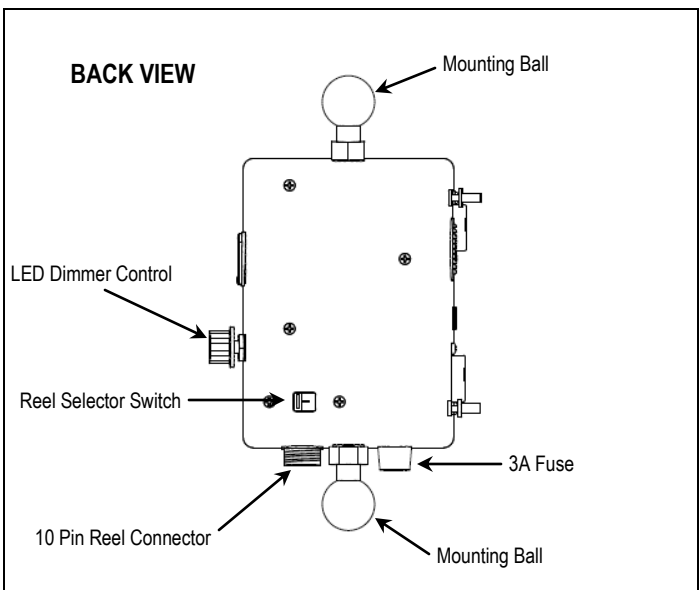
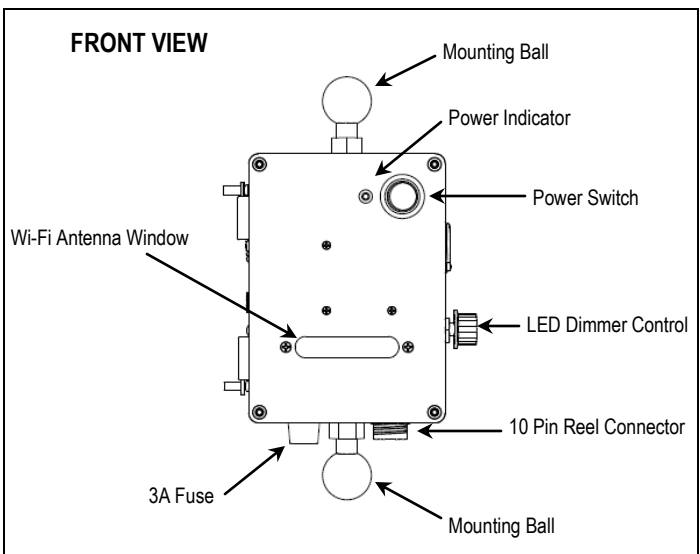
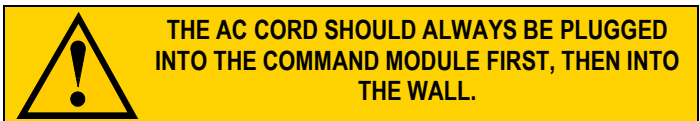

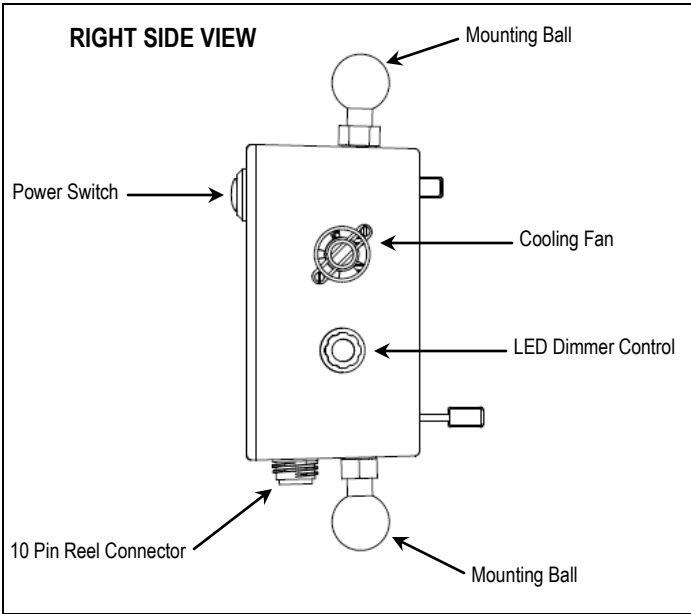

**POWER SWITCH**

The Power Switch is located on the front of the Command Module with an indicator light next to it. Be sure the unit is plugged into a properly grounded outlet before turning it on.

**WI-FI ANTENNA**

The Wi-Fi antenna, located behind the window in the Command Module, sends video to your tablet or Smartphone. A free App lets you easily view and record video inspections at a range of up to 500 feet. Software can be downloaded free from Apple, or Android from Google Play. See Wi-Fi section for more details.

**USB POWER PORT**

Charge your tablet, iPad, iPhone, Android, or Apple device as you do your inspection. Just plug it into the Power Port located on the upper left side of the Command Module. Do not charge the battery if the air temperature is below 30° F or above 104° F. Use the Connector Dust Cover when not in use to keep dirt out of the connector.

**AC POWER INPUT**

Plug the AC power cord into the AC power input connector on the left side of the Command Module. Be sure the 120 volt AC outlet you are using properly grounded to prevent damage to the unit.

**LED DIMMER CONTROL**

You can adjust the camera LED light level by using the dimmer knob located on the right side of the Command Module.

**REEL SIZE SWITCH**

To insure the footage counter is as accurate as possible, be sure the Reel Size switch is set to match the reel you are using - Standard or Mini-Reel. The switch is located on the back of the Command Module.

**REEL CONNECTOR**

Connect the interface cord from standard or mini-reel to 10 pin Reel Connector, located on the bottom of the Command Module. If using the Prism with the Gen-Eye POD, use the optional GL-ICP interface cord. Connect one lead with the RCA plug to the POD Video Out connector and the other lead to the POD Power Inlet connector.

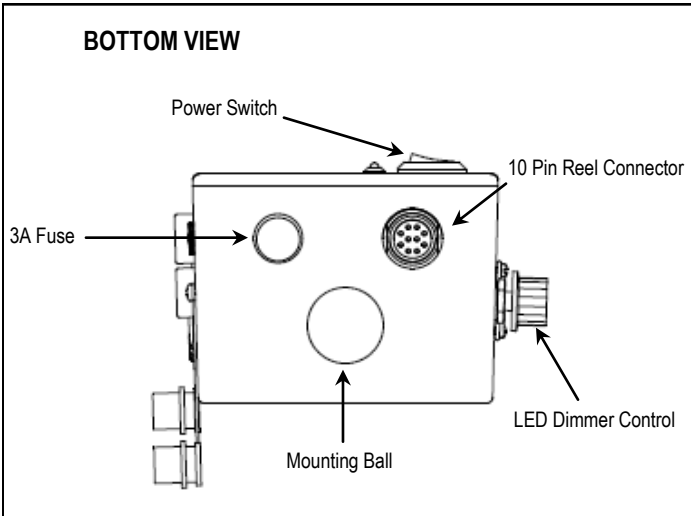

**FUSE**

The 3 amp line fuse is located on the bottom of the Command Module. Should replacement become necessary, replace only with the same value and type as the original. Never substitute fuses as damage may occur and will void your warranty. If the fuses continue to trip for no apparent reason, please consult the factory. Do not use the system until the problem has been corrected.

**EXPANDABLE HOLDER**

The holder mounted above the Command Module can safely support your full size tablet. Just squeeze the pins together to expand the holder to the size you need. Optional holders for the mini-tablet or Smartphone are available. Adjust the holder angle to the optimum viewing angle.

**FOOTAGE COUNTER**

Lets you keep track of how much push-rod you've fed into the line. The switch to set the counter for either standard or mini reels is located on the back of the Command Module. Plug the Keyboard into the lower connector on the left side of the Command Module to reset the counter. See To Set Footage Counter for details.

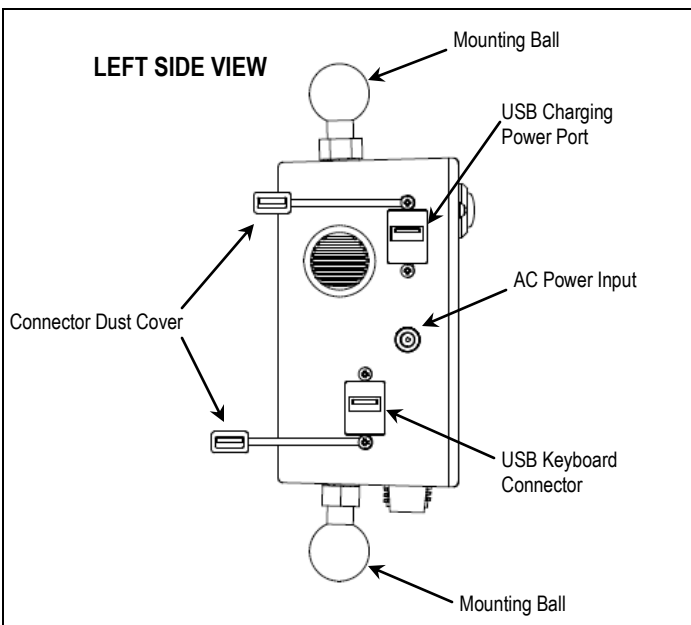

**TITLER WITH FULL KEYBOARD**

The Gen-Eye Prism has an external full keyboard titler. It gives you nine pages of text to easily add your company name and job location to your inspection videos. The Keyboard is also used to reset the footage counter. To activate it, plug it into the USB Keyboard connector on the lower left side of the Command Module. Use the Connector Dust Cover when not in use to keep dirt out of the connector.

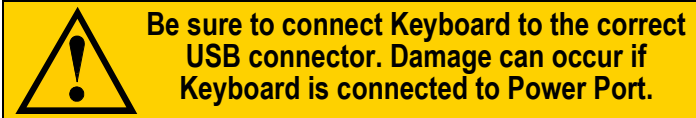

**SAVING A PAGE**

To save a page to memory:

1. Go to the page you wish to save by pressing [ESC] followed by 1-9 (example: [ESC]+[5]).
2. Type text on-screen.
3. Press [F-5] to save screen text to the selected page.

**KEYBOARD/COUNTER OPERATING INSTRUCTIONS**

Key	Function
F1	Cursor ON/OFF
F2	Clear screen and place cursor at home position. (i.e. top left corner)
F4	Press [F4] followed by [+] or [-] and five digits. Press [ENTER] to confirm.
F5	Save current on-screen text to memory page.
F6	Time and date ON/OFF toggle.
[ENTER]	Move cursor to next line.
◀	Backspace erases letter and goes back one position.
[ESC]	[ESC] followed by 1-9 recalls saved pages on screen.
[CTRL]-D	Set Time/Date. Press [ENTER] to quit.
[CTRL]-C	Reposition counter in one of four corners and the bottom center of the screen.
[CTRL]-B	Type black characters with white border.
[CTRL]-F	Turns flashing characters ON.
[CTRL]-N	Turns flashing characters OFF.
[CTRL]-W	Type white characters.

**TO SET FOOTAGE COUNTER**

Make sure the Reel Selector switch, located on the back of the Command Module, is set for the reel you are using. Before starting the inspection, place the camera in the line and zero your counter. This is your starting point for measurements.

1. To set the footage counter to zero [000.0], press [F-4] followed by [ENTER].
2. To set the footage counter to a preset value, press [F-4], then press either [+] or [-] followed by five digits (numbers).

**SETTING TIME/DATE**

1. Hold [CTRL] and press D. "YYMMDDHHMMSSam" appears on the screen.
2. Type in the correct time and date in this order: Year, Month, Day, Hour, Minutes, Seconds, AM/PM (a for AM and p for PM).
3. If you wish to quit, simply hit the [ENTER] button and date and time entry line will disappear.
4. Note: The clock is preset for 12 hour mode (i.e. 01 to 12).

**CAMERA AND REELS**



**Table 1—Reel Selection Guide**

Reel Type	Pipe Sizes	Lengths Available
Standard Reel	3" to 10" (75 to 250mm)	200, 300, or 400 ft. (60, 90 or 120m)
Mini Reel	1-1/2" to 4" (38 to 100mm)	100 or 200 ft. (30 or 60m)

**SELF-LEVELING COLOR CAMERA**

The self-leveling color camera automatically keeps the picture right side up as the camera glides through the line. You always have an upright picture on the monitor, making it easier for you and your customers to follow the action.

**COLOR CAMERA**

Color camera provides a crisp, clear picture. Available on standard and mini-reels.

**CAMERA TRANSMITTER (512HZ)**

The camera assembly includes a 512 Hz transmitter, located safely in the spring behind the camera head. When the Command Module is turned on, the transmitter is automatically activated.

---

**NOTE: CARE SHOULD BE TAKEN WHEN GUIDING THE CAMERA IN THE LINE AS EXCESSIVE BENDING AND TWISTING MORE THAN 180 DEGREES MAY DAMAGE ELECTRONICS IN THE SPRING.**

---

## SKIDS

It is highly recommended that you use a skid at all times to protect the camera head from abrasion in the pipe. Skids lift the camera off the bottom of the pipe and center it in the line for a better view and to allow the camera to glide more easily through the line.

The standard reel comes with 2", 3", and 6" trap skids. Other optional skids are available for 6", 8" and 10" lines:



To attach the skid, slide it over the front of the camera head, with the lip of the skid at the front. Make sure the camera body is clean and the set screws are tightened only until they touch the camera body. Do not over tighten, as you may damage the camera housing.

## ASSEMBLY

The Docking Clamp allows the Prism Command Module to be mounted on any GL Reel or Gen-Eye POD. Your unit comes with a clamp, two extenders and a holder for a standard size tablet. To assemble:

1. Place one extender on the mounting ball on bottom of the command Module.
2. Place the mounting ball on the clamp into the other end of the extender, then tighten the knob on the side of the extender.
3. Place one extender on the mounting ball on top of the command Module.
4. Place the mounting ball on the back of the expandable holder into the other end of the extender, then tighten the knob on the side of the extender.
5. Place the clamp onto the tubular frame of your reel and tighten the knob on the clamp.
6. Squeeze the pins behind the holder together to expand the holder to the size you need. Then place your tablet in the holder and release the pins. Optional holders for the mini-tablet or Smartphone are available.
7. Then adjust the Tablet and holder angle for the optimum viewing angle.



## SET UP

### Pre-Inspection Procedure

1. Upon arrival to the job site, set up the Gen-Eye Prism in an easily viewable position where it will not interfere with the inspection.
2. Unwind the interface cord from the side of the reel and plug it into the 10 pin Reel Connector on the bottom of the Command Module. Insure the connector is properly aligned and then tighten.

Note: If using the Prism with the Gen-Eye POD, use the optional GL-ICP interface cord. Connect one lead with the RCA plug to the Video Out connector and the other lead to the Power Inlet connector.

3. Plug the AC cord into 120VAC input on the left side of the Command Module, before plugging it into a power source. Be sure the AC power source is properly grounded.
4. Turn on the Power Switch to activate the Command Module. The indicator light will illuminate.
5. Turn on tablet or Smartphone, open the appropriate App, and confirm you are receiving a picture from the camera. If you have not yet set up your tablet or Smartphone for pipe inspection, see the How to Set up Wi-Fi section.

## OPERATION

1. Release the reel lock and loosen the drag break on the side of the reel.
2. Slide the camera into the line. Be sure that the push rod is rated for the size pipe you are inspecting. Be careful not to force the camera around tight bends. If you see an obstruction, stop. Do not attempt to clear the pipe by using the camera head. Always use the proper tool for the job.
3. Once the camera is in the pipe, adjust the lights to a level which produces the best picture with the least amount of light. This will vary depending on pipe conditions. In some cases white or lighter colored objects may cause the picture to "flare" or "wash out". If this happens, simply adjust the light level until a good picture is achieved.
4. Push the camera slowly and carefully during the inspection - taking note of the pipe condition for possible hazards that may entangle or damage the camera on entry or retrieval.
5. When negotiating a corner, care should be taken not to butt the nose of the camera against the sidewall with any force. It would be better to let the camera "work" its way around the corner.
6. Should resistance become extreme, or the camera gets entangled or stuck, slowly push and pull back and forth to free it. Sometimes rotating the push rod may also help.



## How to Set-Up the Wi-Fi Feature for Gen-Eye Prism 2.0 Camera Systems On an Apple device

1. Make sure the Prism Command Module is turned ON and you are next to the unit.
2. On your cell phone, tablet, or other Wi-Fi enabled device, go to the App Store.  
**NOTE:** You must have an Apple account set up before proceeding.
3. Search for and download “G-Pipe Wifi Viewer”.
4. On your device, open “Settings” and select “Wi-Fi”. Make sure Wi-Fi is ON.

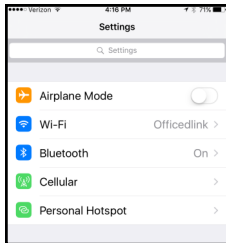
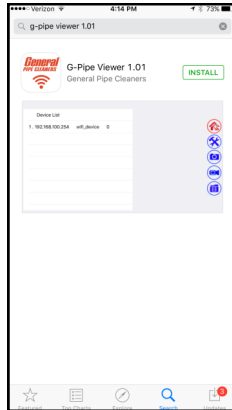

5. Select “WIFI\_XX:XX:XX\_” (the numbers/ letters appearing after “WIFI\_” will vary by unit), and join. **Password: 12345678**
6. Open the downloaded WIFI VIEWER app on your device.

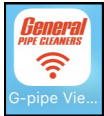

iOS icon

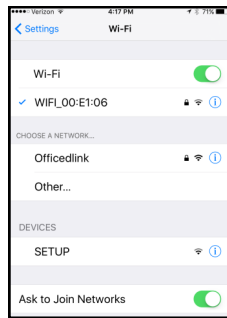



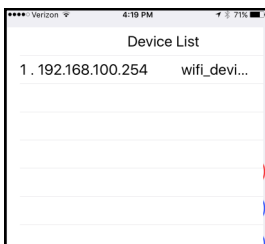



7. When the app opens, a chart will appear. Select “wifi\_device”.



8. You should see the image transmitted by the camera on your screen.



9. You are now ready to record video or take snap shots.

	<b>Icon Key:</b>
	Home—takes you back to the main screen (devices list)
	Tools—opens the settings menu for video, camera and audio. <i>Adjust brightness, contrast, resolution, etc.</i>
	Camera—tap to take snap shots
	Video Camera—tap to begin/end recording video
	File Folder—video/photo gallery (snap shots and videos are

The number of photos and/or the length of video you can shoot will depend on the amount of storage available on your device.

10. To take a snap shot, tap the camera icon.
11. To start recording video, tap the video camera icon. (Tap it again to end recording).
12. To adjust the brightness, contrast, etc., tap the tools icon and select your desired settings.
13. To view your snap shots and recordings, tap the file folder icon in the WiFi Viewer app and select either the “Picture” or “Record” file, then tap the image/video file you want to view. You can also view your photos/videos in your device’s gallery.





## How to Set-Up the Wi-Fi Feature on Gen-Eye Prism 2.0 Camera Systems On an Android device

1. Make sure the Prism Command Module is turned ON and you are next to the unit.
2. On your cell phone, tablet, or other Wi-Fi enabled device, go to the Play Store (Android). **NOTE:** You must have a Google account set up before proceeding.
3. Search for and download “G-Pipe Wifi Viewer”.

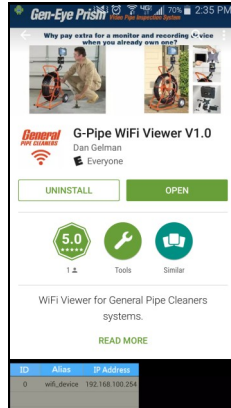
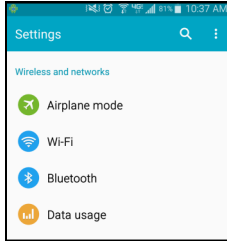

4. On your device, open “Settings” and select “Wi-Fi”.
5. Select “WIFI\_XX:XX:XX\_” (the numbers/ letters appearing after “WIFI\_” will vary by unit), and connect. **Password: 12345678**
6. Open the downloaded WIFI VIEWER app on your device.

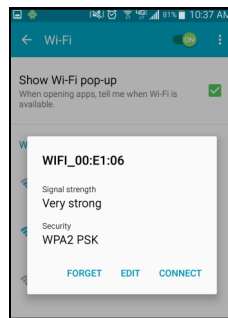

Android icon

7. When the app opens, a chart will appear. Select “wifi\_device”.

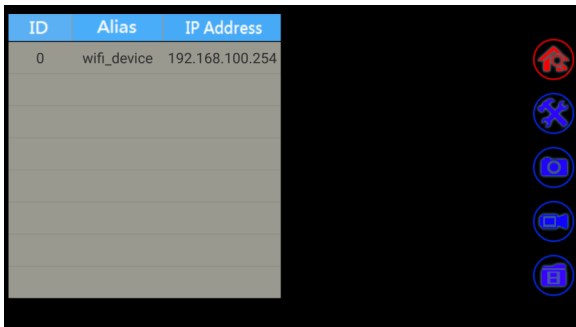

8. You should see the image transmitted by the camera on your screen.



9. You are now ready to record video or take snap shots.

	<b>Icon Key:</b> Home—takes you back to the main screen (devices list)
	Tools—opens the settings menu for video, camera and audio. Adjust brightness, contrast, resolution, etc.
	Camera—tap to take snap shots
	Video Camera—tap to begin/end recording video
	File Folder—video/photo gallery (snap shots and videos are

The number of photos and/or the length of video you can shoot will depend on the amount of storage available on your device.

10. To take a snap shot, tap the camera icon.
11. To start recording video, tap the video camera icon. (Tap again to end recording).
12. To adjust the brightness, contrast, etc., tap the tools icon and select your desired settings.
13. To view your snap shots and recordings, tap the file folder icon in the WiFi Viewer app and select either the “Picture” or “Record” file, then tap the image/video file you want to view. You can also view your photos/videos in your device’s gallery.

**NOTE:** Your Android device may not be equipped to recognize the file type used for the video. IF THIS HAPPENS, go to the Play Store and download “MX Player”. This is a free app with ads—they offer an ad-free version for a small fee.

Then, open the desired video from the WiFi Viewer app, or from your device’s gallery. You will be asked what program you want to use to play the video. Select “MX Player”.

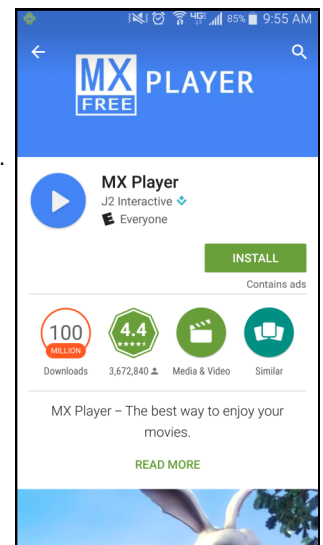

## CAMERA LOCATION

1. Turn on Gen-Eye Prism Camera system.
2. Press and hold the Hot Spot Locator On/Off button. Check battery strength on display.
3. Press MODE icon until indicator displays Sonde/Camera Head mode.
4. Press Antenna Select icon until indicator displays Total Field configuration.
5. Set Locator to 512Hz by pressing FREQ button until 512 Hz appears on display.
6. Press up arrow button to increase GAIN to maximum sensitivity.
7. Push camera head/Sonde only 10 to 15 feet into the line before starting the location process.
8. Stand near pipe entrance and hold the Gen-Eye Hot Spot Locator so that the blade is pointed at 45 degree angle, out and down towards the ground at the approximate distance of the transmitter.
9. Rotate in a circle, listening to the signal strength indicator tone. If you receive full signal strength in every direction, press and release the DOWN ARROW button to reduce the GAIN, or sensitivity of the device. Repeat process until you receive a strong-steady tone from just one direction. Reduce gain further if necessary to clarify exact direction.
10. Hold Hot Spot Locator blade perpendicular to the ground and walk in the direction of the strongest signal.
11. As you walk, reduce gain by pressing and releasing down arrow button as often as necessary to keep signal strength indicator near the 50% level. (Signal Strength levels in the 100% range will erode accuracy. Always aim to keep the signal strength near 50%.)
12. The radio waves propagating from the transmitter look like this:

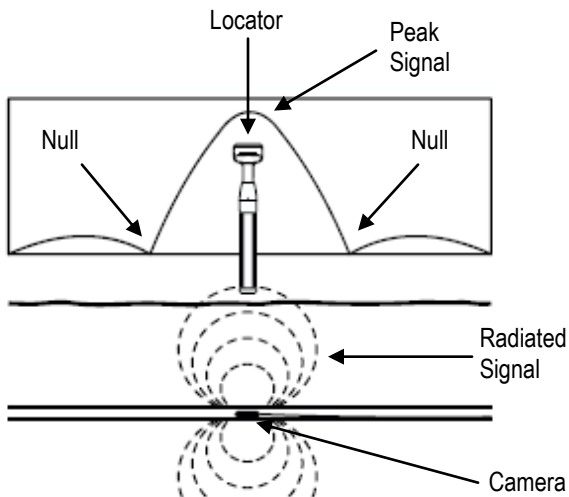

Notice that there is a PEAK signal over the exact location of the transmitter, and two NULL points on either side of the PEAK, lined up parallel with the lay of pipe.



13. Watch the Gen-Eye Hot Spot monitor display as you approach the transmitter's location.
14. When you reach the vicinity of a NULL point the screen will produce this display:



Simply follow the arrows to find the exact spot. When you are over the NULL point, the screen will produce this display.

15. When you reach the vicinity of the PEAK the screen will produce this display:



Follow the arrow to pinpoint the location of the transmitter. Simply rotate the flat edge of the locator blade relative to the arrows on the outside of the 'compass' to determine the orientation of the transmitter. When the display shows this graphic:



you will have the exact location of the transmitter and the lay of the pipe.

16. Find and mark the location of both the NULL and the PEAK points.
17. Push the camera ahead another 10-20 feet and repeat the process. Duplicate every 10-20 feet until the problem area is visible on the Gen-Eye monitor. At the completion of this process the entire line will be traced and marked.

## MAINTENANCE



**DISCONNECT MACHINE FROM POWER SOURCE BEFORE PERFORMING MAINTENANCE ON MACHINE!**

## CAMERA MAINTENANCE

### CAMERA CLEANING

After every use, the camera should be cleaned and checked for possible damage that may have occurred during the inspection. External scuffing of the camera housing is normal and should be of no concern; however, use the trap skid to protect the camera and help it slide around elbows more easily. The camera lens is made of sapphire and should be cleaned with a soft, damp cloth. Grease, dirt, or scratches will affect the quality of the video picture.

### CAMERA FOCUS

All Gen-Eye cameras are pre-focused at the factory from approximately 3" to infinity and should not require any focus adjustments. Should focus adjustments be required, please call the factory.

### LIGHT HEAD REPLACEMENT

The lights for the Gen-Eye cameras use LED lighting and cannot be replaced by the operator. These lights use very little power. Unless physically damaged or extreme voltage is applied to them, they should last indefinitely. If replacement is necessary, the camera should be returned to the factory. The camera lights are wired in a series/parallel configuration. This means that there are 4 sets of 4 (color camera) each wired together. Each set is wired in series and then the 4 sets are wired in parallel. Therefore, should one lamp burn out in one set, the other sets will still remain lit.

## CAMERA REMOVAL



**TO PREVENT DAMAGE TO THE CAMERA AND/OR SYSTEM, DISCONNECT POWER FROM THE COMMAND MODULE BEFORE REMOVING OR RECONNECTING THE CAMERA TO THE REEL.**

The camera and associated electronics are not user serviceable. Servicing must be done by qualified personnel. Contact the factory to locate a service center near you. To use the Camera Test Terminal (see instructions below) to diagnose a problem, or to return camera to the factory, the following instructions should be used with extreme care.

1. Disconnect the complete camera and spring assembly by removing the 3 screws (4-40 x ½ SSTL) that are countersunk into the cone-shaped aluminum coupler at the end of the push cable. The screws can be removed using the Xcelite allen wrench provided with the unit. Screws should be removed very carefully and simultaneously. Each screw should be turned approximately one (1) full turn alternatively, so as not to damage the connector. While backing out each screw, hold the connector and camera assembly together until all the screws are out and then unplug the camera from the cable reel taking care not to lose the O-ring or screws.

2. After disconnecting the camera assembly, inspect the O-ring for any damage, and if worn, replace it with a new one. Also, when replacing any O-rings, make sure there is no dirt or grit on it, as it may not seal properly. Apply silicone grease or petroleum jelly to the O-ring for proper sealing.
3. To reconnect the camera assembly, carefully align the rear connector on the camera assembly and the push rod connector. When aligned, push the connectors together and replace the screws. (If the connectors do not align properly, turn the camera body slowly while slightly pushing the two connectors together until you feel them align properly together.)



**DO NOT FORCE THE CONNECTORS TOGETHER. DAMAGE MAY OCCUR TO THE CONNECTORS.**

## PUSH ROD AND REEL ASSEMBLY CLEANING



**DO NOT USE A POWER WASHER TO CLEAN THE REEL. WATER MAY GET INTO UNSEALED AREAS, REEL HUB ASSEMBLY AND SLIP RING HOUSING, CAUSING DAMAGE AND VOIDING THE WARRANTY.**

The push rod and reel assembly should be kept clean from dirt. When rewinding the cable back onto the reel after an inspection, it is good practice to use a clean rag to wipe off any debris.

## **ADDITIONAL MAINTENANCE TIPS**

- The camera should always be cleaned and inspected after every use as dirt, grime and grease can cause unnecessary problems such as failure of the camera seals.
- The camera spring is attached to the cable via three (3) 4-40 x 1/2" stainless steel hex socket cap screws. This connection includes an O-ring sealing the connection from water leakage. This connection should be checked after every use to ensure that the screws have not loosened during the course of the inspection.
- If disconnecting the camera from the push rod, make sure that the O-ring is in good condition and/or replaced when replacing the camera onto the push rod.
- The camera lens, front nose piece and lights should be cleaned and checked after every use for possible damage to the lens or light covers and to prevent a build-up of dirt and grime which may cause a degradation of the video picture.
- Should camera disassembly be required for any reason (for replacing seals, etc.) always ensure the camera has first been cleaned and taken to a clean area for disassembly. Take extra precaution to avoid dirt getting into the camera body and any mating components such as the nosepiece, main body, and connectors.

## **TROUBLESHOOTING COMMAND MODULE**

### **No Picture AND No Lights:**

- Check to see if the Main Power switch is ON. Check to make sure the power source is "live" (for 120 volt AC) or check to see if the light is lit on the cigarette lighter plug (for 12 volt DC).
- Check to make sure that the camera lens is not covered or looking at a surface that provides no detail, therefore any image detail.
- Check all connections and connectors from the camera back to the Command Module, including the cable reel.
- Disconnect main power and contact the factory service department.

### **Picture BUT No Lights:**

- Check if Main Power switch is ON.
- Check to see if LIGHT LED Dimmer control is turned up.
- Check cable for possible breaks or intermittent open circuits by flexing the cable.
- Disconnect main power and contact the factory service department.

### **No Picture, Lights OK**

- Check Monitor power switch is ON. Check to make sure the power source is "live" (for 120 volt AC).
- Check to see if the power fuse has "tripped". If so, replace with same value (3 amps).
- Check the interface cord for possible damage or intermittent problem by flexing the cable.
- Check the cable for possible breaks or intermittent open circuits by flexing the cable.
- Disconnect the main power source and contact the factory service department.

### **Dark Picture**

- Check the Light Head to see if it is not supplying sufficient light due to weak, dirty, or burned out bulbs.
- Check to see if the Light LED Dimmer control is turned up.
- Disconnect the main power source and contact the factory service department.

### **Bad or Grainy Picture**

- Check the camera lens for dirt, grime, scratches or other foreign matter.
- Check the lights in the camera head to see if they are not supplying sufficient light due to weak, dirty, or burned out bulbs.
- Check for external electrical noise being radiated by outside sources, such as a power station, etc.
- Check the cable for possible breaks or intermittent open circuits by flexing the cable.
- Disconnect the main power source and contact the factory service department.

### **Not Recording**

- Check that your device is receiving a good video image.
- Check that your device has enough video storage space.
- See the instructions for your device for other solutions.

FOR ALL OTHER FUNCTIONS RELATIVE TO THE SD RECORDER OR MONITOR UNIT, PLEASE CONSULT YOUR RECORDER OR MONITOR OWNER'S MANUAL.

**General Wire Spring Co.**  
**1101 Thompson Avenue**  
**McKees Rocks, PA 15136**

**412-771-6300**

**[www.drainbrain.com](http://www.drainbrain.com)**